

scheda tecnica - data sheet

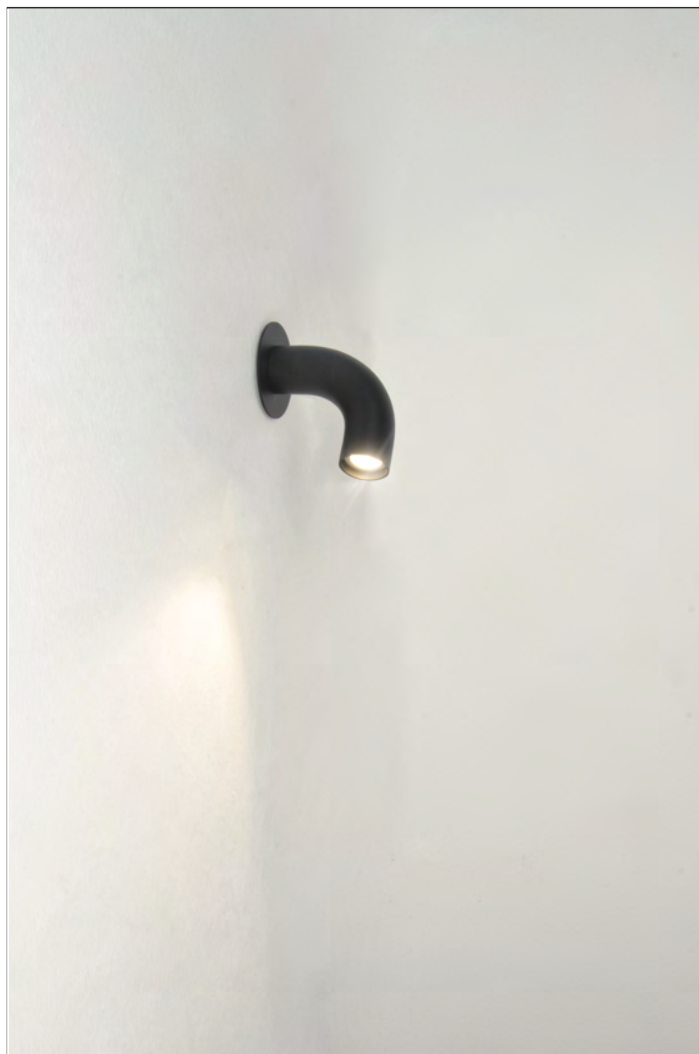

modello:
model:

RACCORDI DI LUCE

codice:
code:

4673

design:

Officina di Architettura e Design

anno - year:

2022

tipologia:

lampada da parete IP65

typology:

IP65 wall lamp

materiali:

acciaio INOX e alluminio

materials:

stainless steel and aluminum

luce:

radente

light:

grazing

sorgente luminosa:

/W LED 2W 500mA 209lm 4000K

light source:

/WW LED 2W 500mA 199lm 3000K

/XW LED 2W 500mA 189lm 2700K

life

> 50.000 h

step MacAdam

3

Indice di Resa Cromatica:

>80

Color Rendering Index:

grado IP - IP grade:

65

peso netto - net weight:

0,25 Kg

finiture - finishes:

.01 bianco

.01 white

.02 nero

.02 black

.06 verde

.06 green

.33 INOX AISI 316L

.33 stainless steel

.34 verniciato corten

.34 painted corten

alimentatori - drivers:

0127 driver 500mA

0143/IP driver IP67 500mA

marcatore:

CE

marking:

simboli costruttivi:

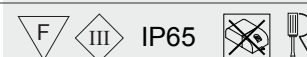
F III IP65 

symbols:

Dimensioni - Dimensions

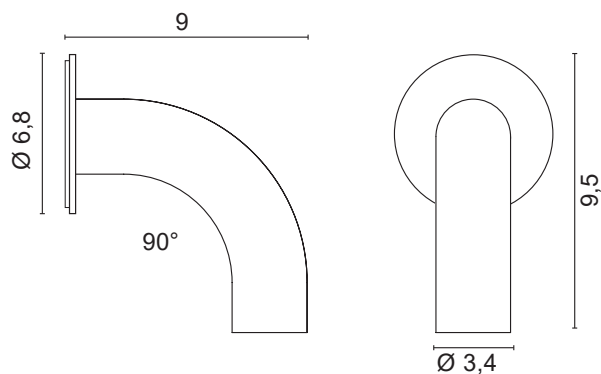

.01 bianco - white

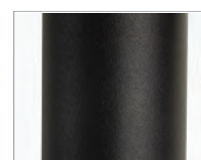

.02 nero - black

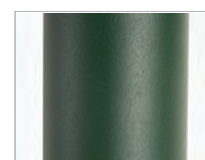

.06 verde - green



.33 INOX AISI 316L
stainless steel

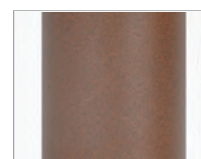

.34 verniciato corten
painted corten

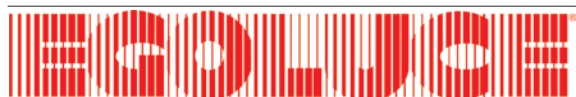

EGOLUCE s.r.l., via I.Newton 12 - 20016 Pero - Milano
telefono +39 02 339586.1 - fax. +39 02 3535112
e-mail: info@egoluce.com - http://www.egoluce.com